

Specifications:
 Material And Finish:
 Insulator:PA66 UL94-V0 Color:Natural
 Contact:Brass

Rating:
 Current Rating:16.0 Amp
 Voltage Rating:250V AC/DC
 Operating Temperature Range:-25~+85°C

Electrical:
 Contact resistance:20m Ohm Max
 Insulator resistance:1000M ohm min.
 Withstanding Voltage:1000V AC/Minute

Ordering Information
 RAST5001S-XXX-X-XXC
 1 2 3 4 5 6 7

- 1: — Series No.
- 2: — S: Straight Type
- 3: — No. of Positions
- 4: — A: Gold Flash
S: Matter Tin Plated
AG: Silver plating
- 5: — 1: Terminal Type 1
2: Terminal Type 2
- 5: — Fool proof type
(See the attached page for details)
- 6: — C: In Tray

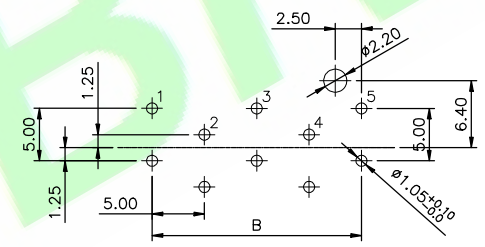
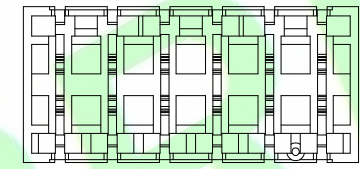
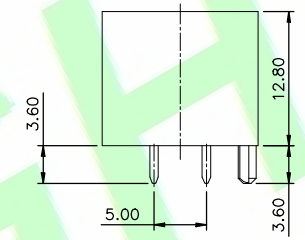
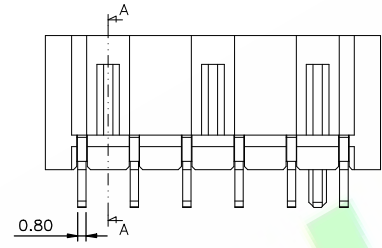
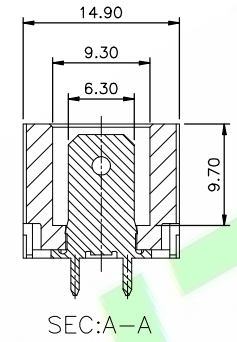
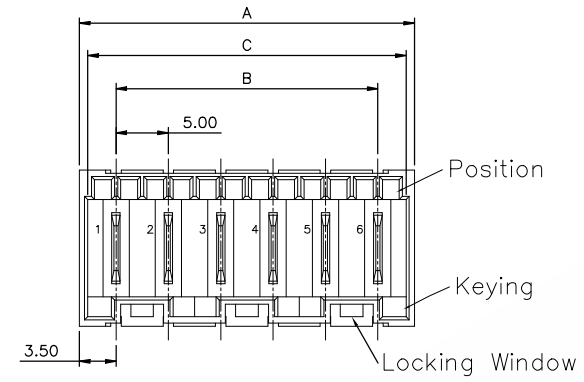

For Terminal Type 1
P.C.B Layout

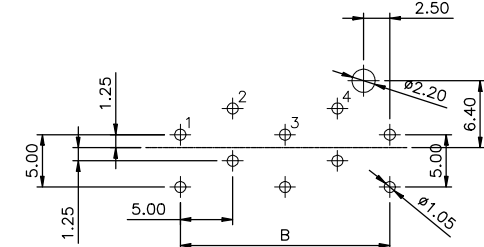

For Terminal Type 2
P.C.B Layout

No.	Dimension mm		
	DIMA	DIMB	DIMC
02	12.00	5.00	10.20
03	17.00	10.00	15.20
04	22.00	15.00	20.20
02	27.00	20.00	25.20
05	32.00	25.00	30.20
06	37.00	30.00	35.20
07	42.00	35.00	40.20
08	47.00	40.00	45.20
09	52.00	45.00	50.20
10	57.00	50.00	55.20
11	62.00	55.00	60.20
12	65.00	60.00	65.20

5X			
4X			
3X			
2X	New anti-dork structure	Judyyan	20221207
1X	ORIGINAL	Mark	
REV.	DESCRIPTION	DR.BY	ECN. NO.

DR.BY:	Mark
CHKD.:	Tony
APPD.:	Billy

GENERAL TOLERANCE:	PART NO : RAST5001S-XXX-X-XXC
LINEAR	DWG. NO.:
ANGLES	TITLE : 5.0mm Pitch RASTER R/A Type
X.: ±0.30	X': ±5.0°
X.X: ±0.25	X.X': ±3.0°
X.XX: ±0.15	X.XX': ±2.0°
X.XXX: ±0.10	X.XXX': ±1.0°
DATE: 28-Aug-2021	

HJBRIGHT 東莞市華晶電子有限公司
 BRIGHT-E ELECTRONIC TECHNOLOGY LIMITED

SHEET: 1/2
 SCALE: 1:1
 UNIT: mm

THIRD ANGLE PROJECTION

A4

1. Anti-fool type option 2~11P

2Polig/2-Way

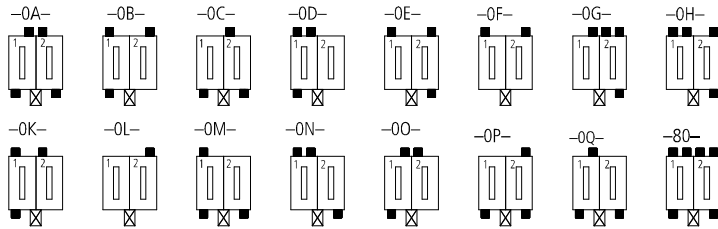

5Polig/5-Way

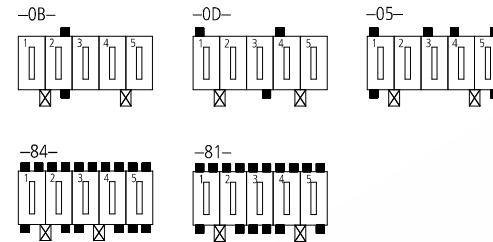

11Polig/11-Way

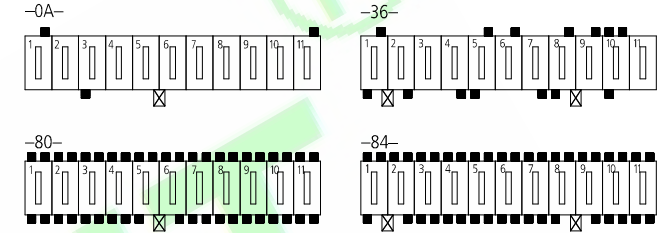

3Polig/3-Way

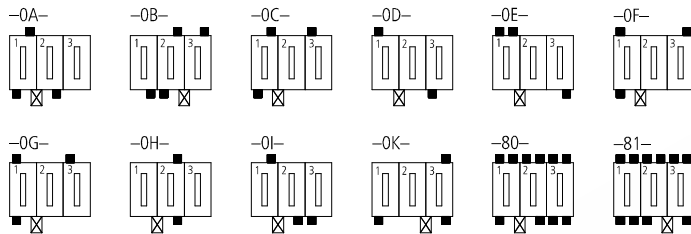

6Polig/6-Way

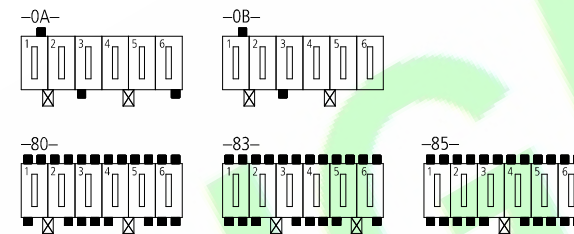

10Polig/10-Way

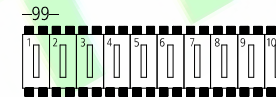

4Polig/4-Way

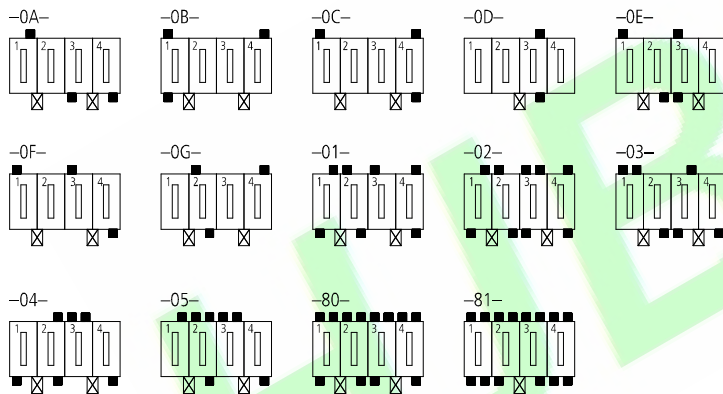

7Polig/7-Way

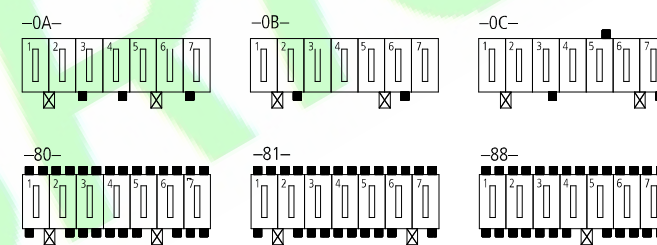

9Polig/9-Way

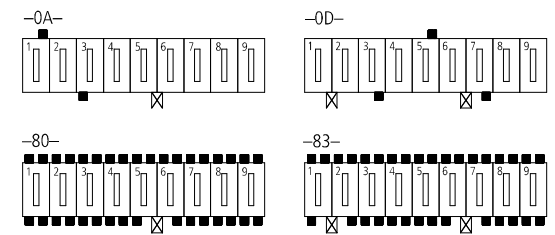

8Polig/8-Way

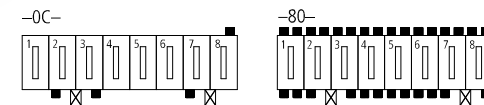

5X				DR.BY.:	
4X				Mark	
3X				CHKD.:	
2X	New anti-dork structure	Judyyan	20221207	Tony	
1X	ORIGINAL	Mark		APPD.:	
REV.	DESCRIPTION	DR.BY	ECN. NO.	Billy	

GENERAL TOLERANCE:	
LINEAR	ANGLES
X.: ±0.30	X': ±5.0°
X.X: ±0.25	X.X': ±3.0°
X.XX: ±0.15	X.XX': ±2.0°
X.XXX: ±0.10	X.XXX': ±1.0°

PART NO :	RAST5001S-XXX-X-XXC
DWG. NO.:	
TITLE :	5.0mm Pitch RASTER R/A Type
DATE:	28-Aug-2021

HJBRIGHT® 东莞市華晶電子有限公司
BRIGHT-E ELECTRONIC TECHNOLOGY LIMITED

SHEET: 2/2
SCALE: 1:1
UNIT: mm

THIRD ANGLE PROJECTION

A4