

Specifications:

Material And Finish:

Insulator:PA6T UL94V-0 Color:Black

Contact: Bronzes>CuSn6<

Tensile Strength>=520MPa

Plated:See Ordering Information

Rating:

Current Rating:3 Amp

Voltage Rating:150V AC/DC

Operating Temperature Range:-40~+105°C

Electrical:

Contact resistance:20m Ohm Max

Insulator resistance:1000M ohm min.

Withstanding Voltage:500V AC/Minute

Mating contact :TE 2-1703930-2 or TE 4-1703930-2

USCAR conform

Ordering Information

18012M-06X119-NXX

1 2 3 4 5 6

1: — Series No.

2: — M:SMT Type

3: — No. of Positions

4: — S:Matte Tin Plated:

4.0-8.0µm(160~320u") Sn over

1.5-3.0µm((60~120u") Ni

AG:3-5.0 µm Ag over 1-3 µm Ni.

5: — 0:W/0 Peg

1:W/1 Peg

6: — G:W/0 Cap In Tape&Reel

F:W/Cap In Tape&Reel

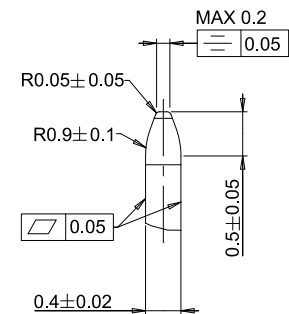
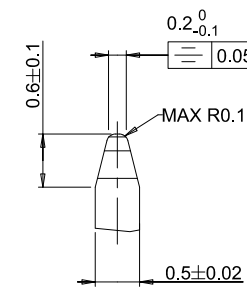
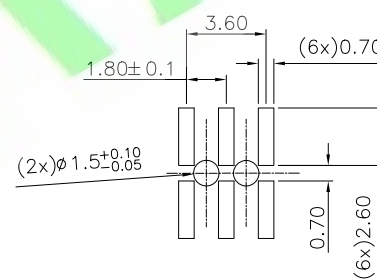
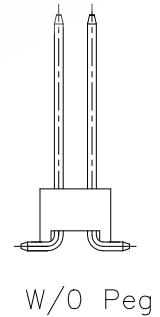
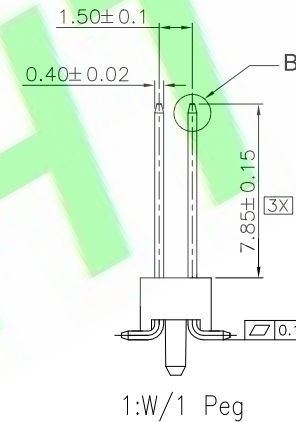
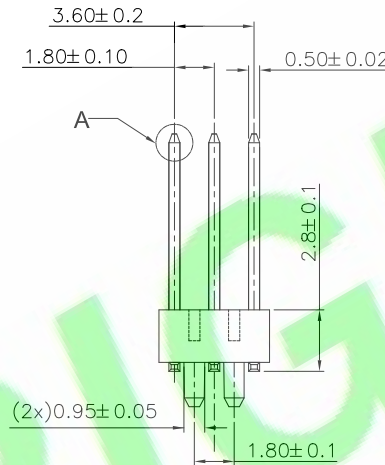
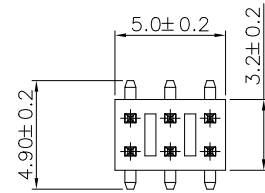

Recommended PCB Layout

4X	Add diagrams	Xiao	20260414
3X	PIN length reduction	Judyyan	20251105
2X	Updating a Drawing	Judyyan	20231111
1X	ORIGINAL	Tsw	
REV.	DESCRIPTION	DR.BY	ECN. NO

DR.BY.: Tsw	GENERAL TOLERANCE:	
CHKD.: Mark	LINEAR	ANGLES
APPD.: Billy	x.: ±0.30	x': ±5.0°
	x.x: ±0.20	x.x': ±3.0°
	x.xx: ±0.15	x.xx': ±2.0°
	x.xxx: ±0.10	x.xxx': ±1.0°

PART NO : 18012M-06X119-NXX
DWG. NO.:
TITLE : 1.80mm Pitch Pin Header SMT Type
DATE: 18-July-2023

HJBRIGHT® 东莞市華晶電子有限公司
BRIGHT-E ELECTRONIC TECHNOLOGY LIMITED

SHEET: 1/1
SCALE: 1:1
UNIT: mm

THIRD ANGLE PROJECTION

A4