

Specifications:
 Material:
 Insulator:PA66 UL94V-0

Rating:
 Current Rating:3.0 Amp
 Voltage Rating:150V AC/DC
 Operating Temperature Range:-25°~+85°C

Electrical:
 Contact resistance:20m Ohm Max
 Insulator resistance:1000M ohm min.
 Withstanding Voltage:500V AC/Minute

Ordering Information
A1503H-XXP

1 2 3

- 1: — Series No.
- 2: — H:Housing
- 3: — No. of Positions

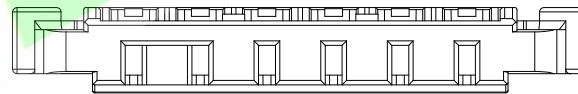
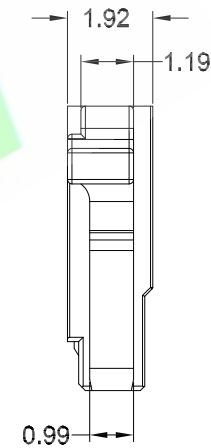
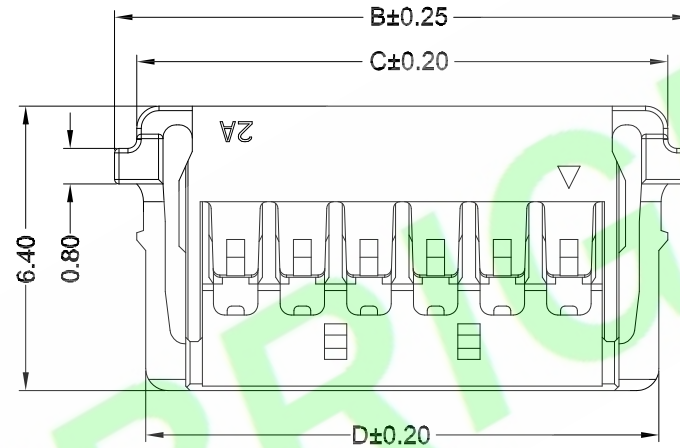
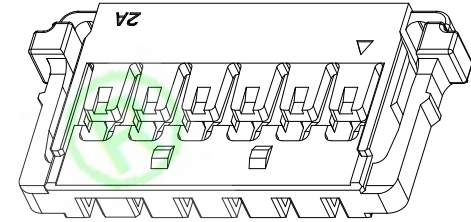
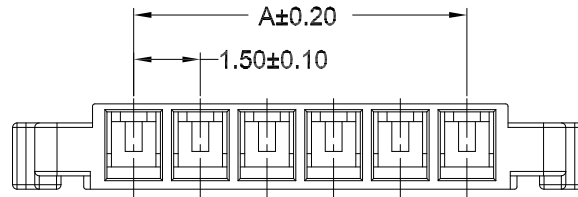

Poles	Dimensions(mm)			
	A	B	C	D
02	3.00	6.95	5.95	5.55
03	4.50	8.45	7.45	7.05
04	6.00	9.95	8.95	8.55
05	7.50	11.45	10.45	10.05
06	9.00	12.95	11.95	11.55
08	10.50	15.95	14.95	14.55
10	13.50	18.95	17.95	17.55
12	16.50	21.95	20.95	20.55

5X				DR.BY.: Samson
4X				
3X				CHKD.: Tony
2X				APPD.: Billy
1X	ORIGINAL	Samson		
REV.	DESCRIPTION	DR.BY	ECN. NO.	

GENERAL TOLERANCE:	
LINEAR	ANGLES
X.: ±5.0°	X': ±5.0°
X.X: ±0.30	X.X': ±3.0°
X.XX: ±0.20	X.XX': ±2.0°
X.XXX: ±0.10	X.XXX': ±1.0°

PART NO : A1503H-XXP
DWG. NO.:
TITLE : 1.50mm Pitch Crimp Style Housing
DATE: 05-Jun-2017

HJBRIGHT 東莞市華晶電子有限公司
 BRIGHT-E ELECTRONIC TECHNOLOGY LIMITED

SHEET: 1/1
SCALE: 1:1
UNIT: mm

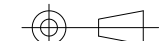

A4

Specifications:
 Material: Phosphor Bronze
 Wire Range: AWG#24~28
 Insulation O.D.: 1.10mm(Max)

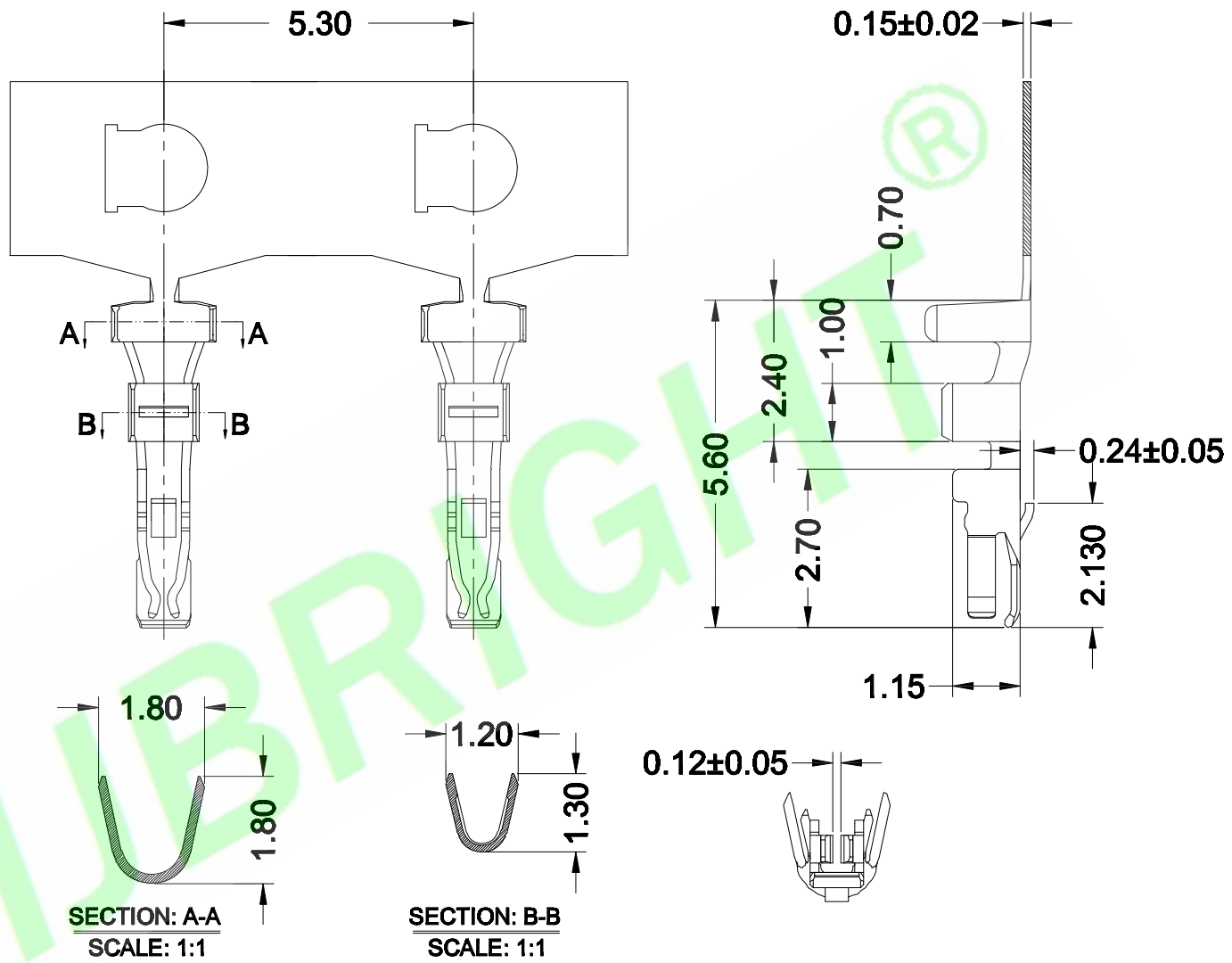

Ordering Information
A1503T-PQ
 1 2 3

- 1: Series No.
- 2: T: Terminal
- 3: Plated:
- Q: Plated Tin

5X			
4X			
3X			
2X			
1X	ORIGINAL	Samson	
REV.	DESCRIPTION	DR.BY	ECN. NO.

DR.BY:	Samson
CHKD.:	Tony
APPD.:	Billy

GENERAL TOLERANCE:	
LINEAR	ANGLES
X.: ±0.30	X': ±5.0°
X.X: ±0.20	X.X': ±3.0°
X.XX: ±0.10	X.XX': ±2.0°
X.XXX: ±0.10	X.XXX': ±1.0°

PART NO :	A1503T-PQ
DWG. NO.:	
TITLE :	1.50mm Pitch Crimp Style Terminal
DATE:	05-Jun-2017

HJBRIGHT 東莞市華晶電子有限公司
 BRIGHT-E ELECTRONIC TECHNOLOGY LIMITED

SHEET:	1/1
SCALE:	1:1
UNIT:	mm

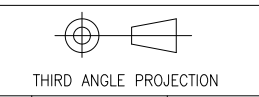

A4