

Specifications:
 Material And Finish:
 Insulator:PA66 UL94V-0

Rating:
 Current Rating:1.0 Amp
 Voltage Rating:50V AC/DC
 Operating Temperature Range:-40~+105°C

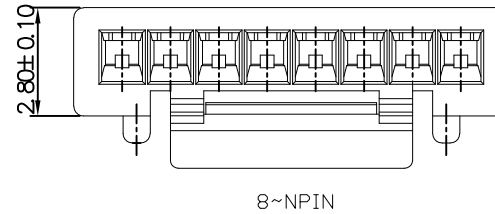
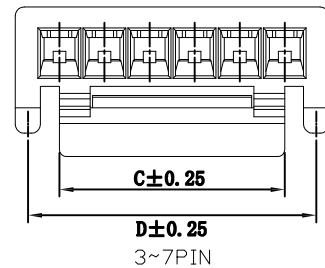
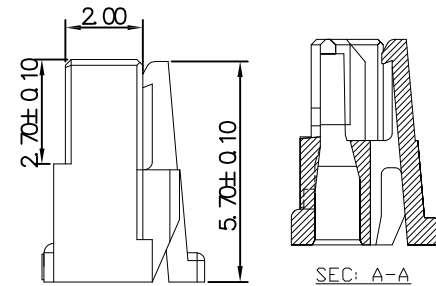
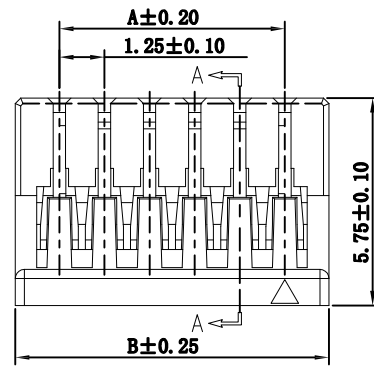
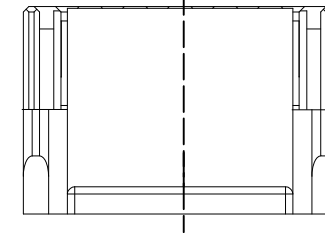
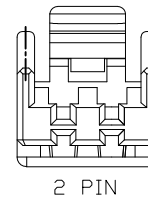
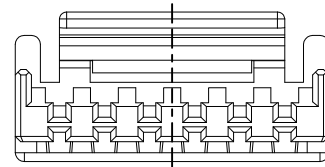

Ordering Information

A1258H-XXP-X
 1 2 3

- 1: Series No.
- 2: No. of Positions
- 3: Color:
 0:Natural
 1:Black
 2:Red
 3:Yellow
 4:Blue
 6:Green
 8:Orange

Circuits	Dimensions			
	A	B	C	D
2P	--	3.65	1.95	3.20
3P	2.50	4.90	3.00	4.20
4P	3.75	6.15	4.15	5.45
5P	5.00	7.40	4.25	6.70
6P	6.25	8.65	6.25	8.00
7P	7.50	9.90	6.25	9.25
8P	8.75	11.15	6.25	8.00
9P	10.00	12.40	6.25	8.00
10P	11.25	13.65	8.25	10.00
11P	12.50	14.90	8.25	10.00
12P	13.75	16.15	8.25	10.00
13P	15.00	17.40	8.25	10.00
14P	16.25	18.65	8.25	10.00
15P	17.50	19.90	8.25	10.00

5X			
4X			
3X			
2X			
1X	ORIGINAL	Tsw	
REV	DESCRIPTION	DR.BY	ECN. NO.

DR.BY.: Tsw	GENERAL TOLERANCE:	
CHKD.: Tony	LINEAR	ANGLES
APPD.: Billy	x.: ±0.30	x': ±5.0°
	x.x: ±0.20	x.x': ±2.0°
	x.xxx: ±0.10	x.xxx': ±1.0°

PART NO : A1258H-XXP-X
DWG. NO.:
TITLE : MICRO-LOCK PLUS 1.25 W/B SINGLE ROW RECEPTACLE HOUSING
DATE: 07-Jun-2021

HJBRIGHT® 东莞市華晶電子有限公司
 BRIGHT-E ELECTRONIC TECHNOLOGY LIMITED

SHEET: 1/1
 SCALE: 1:1
 UNIT: mm

THIRD ANGLE PROJECTION

A4