

RoHS Compliant

Specifications:
 Material And Finish:
 Insulator:PA6T UL94V-0
 Contact:Brass

Rating:
 Current Rating:3.0 Amp
 Voltage Rating:125V AC/DC
 Operating Temperature Range:-40~+125°C

Electrical:
 Contact resistance:10m Ohm Max
 Insulator resistance:1000M ohm min.
 Withstanding Voltage:500V AC/Minute

Ordering Information
 A2019M-XXS-01-XX
 1 2 3 4 5 6

- 1: Series No.
- 2: M:SMT Type
- 3: No. of Positions
- 4: S:Matte Tin Plated
- 5: Color:
 N=Natural
 B=Black
- 6: G:In Tape&reel
 M:Mylar In Tape/Reel

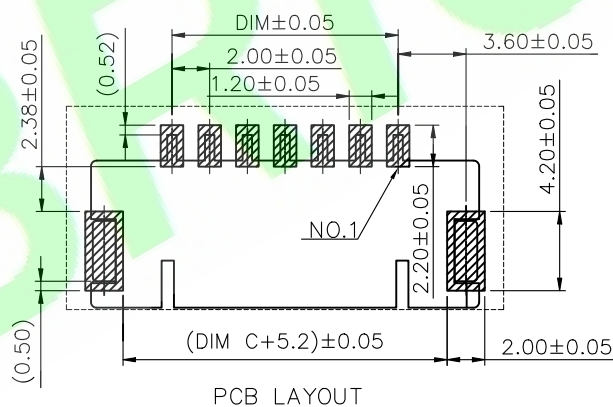
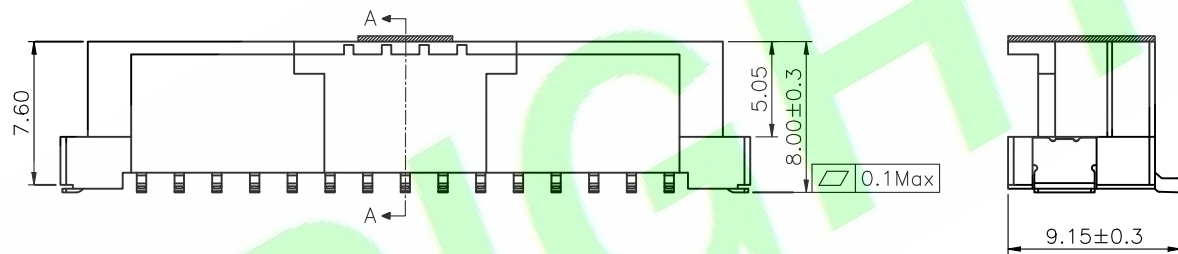
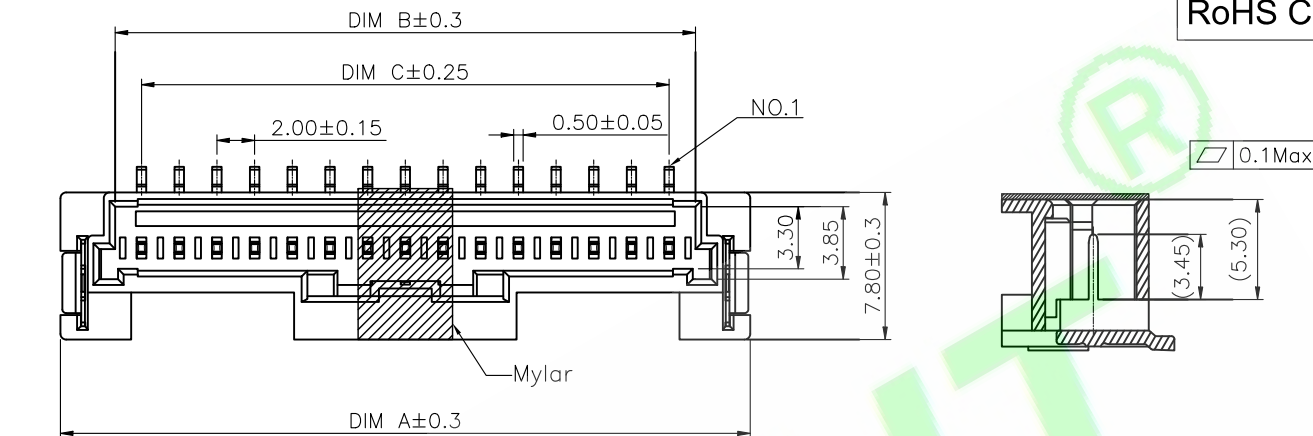

Circuits	DIM A	DIM B	DIM C
2	10.90	4.80	2.00
3	12.60	6.80	4.00
4	14.60	8.80	6.00
5	16.60	10.80	8.00
6	18.60	12.80	10.00
7	20.60	14.80	12.00
8	22.60	16.80	14.00
9	24.60	18.80	16.00
10	26.60	20.80	18.00
11	28.60	22.80	20.00
12	30.60	24.80	22.00
13	32.60	26.80	24.00
14	34.60	28.80	26.00
15	36.60	30.80	28.00

DR.BY.: Judyyan	GENERAL TOLERANCE:		PART NO : A2019M-XXS-01-XX
CHKD.: Aren	LINEAR	ANGLES	DWG. NO.:
APPD.: Billy	X.: ±	X': ±5.0°	TITLE :
	X.X: ±0.30	X.X': ±3.0°	2.0mm Pitch Wafer SMT Type
	X.XX: ±0.20	X.XX': ±2.0°	DATE: 20-Jul-2021
	X.XXX: ±0.10	X.XXX': ±1.0°	

HJBRIGHT 東莞市華晶電子有限公司
 BRIGHT-E ELECTRONIC TECHNOLOGY LIMITED

SHEET: 1/1
 SCALE: 1:1
 UNIT: mm

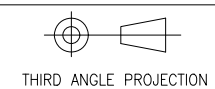

A4

REV.	DESCRIPTION	DR.BY	ECN. NO
3X	Update the plastic material to PA6T	Judyyan	20260429
2X	Update Drawing	Bin	20250709
1X	ORIGINAL	Judyyan	

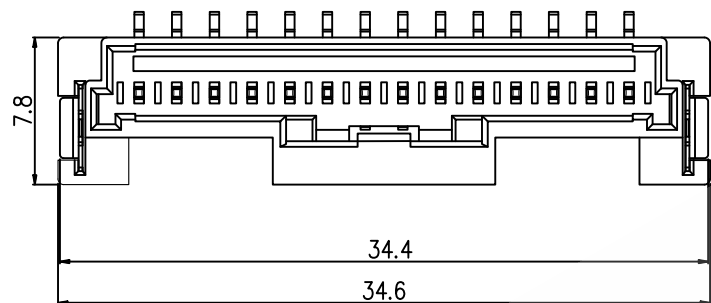

14P

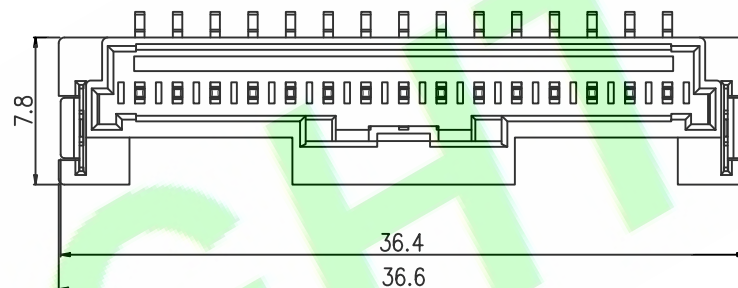

15P

3X	Update the plastic material to PA6T	Judyyan	20260429
2X	Update Drawing	Bin	20250709
1X	ORIGINAL	Judyyan	
REV.	DESCRIPTION	DR.BY	ECN. NO.

DR.BY.: Judyyan	GENERAL TOLERANCE:		PART NO : A2019M-XXS-01-XX	
CHKD.: Aren	LINEAR	ANGLES		DWG. NO.:
	X.: ±	X': ±5.0°		TITLE :
APPD.: Billy	X.X: ±0.30	X.X': ±3.0°		2.0mm Pitch Wafer SMT Type
	X.XX: ±0.20	X.XX': ±2.0°		DATE: 20-Jul-2021
	X.XXX: ±0.10	X.XXX': ±1.0°		

HJBRIGHT 東莞市華晶電子有限公司
BRIGHT-E ELECTRONIC TECHNOLOGY LIMITED

SHEET: 1/1
SCALE: 1:1
UNIT: mm



THIRD ANGLE PROJECTION

A4

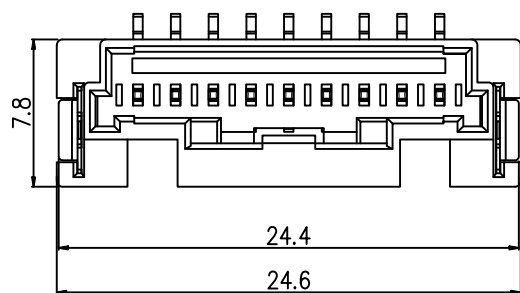

9P

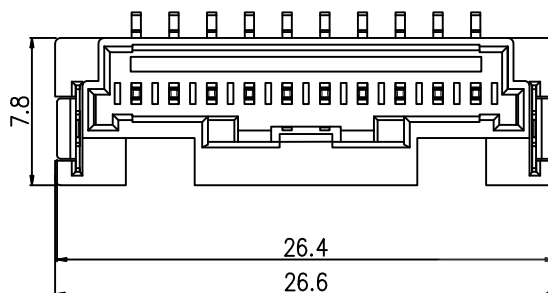

10P



11P

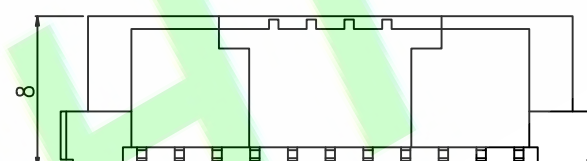
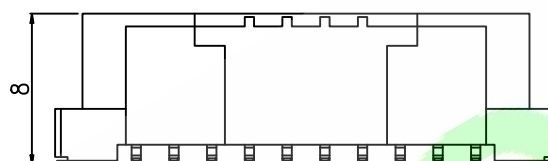
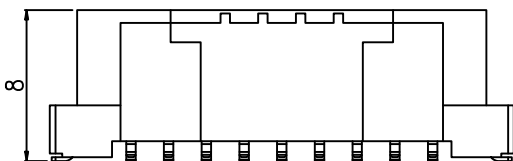

12P

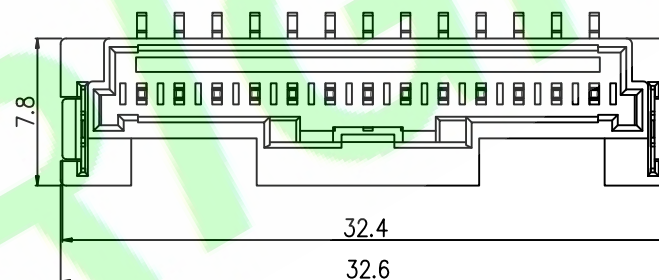

13P

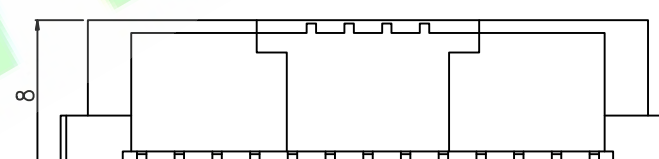
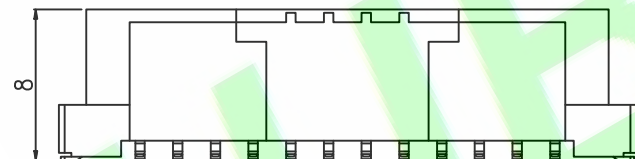

3X	Update the plastic material to PA6T	Judyyan	20260429
2X	Update Drawing	Bin	20250709
1X	ORIGINAL	Judyyan	
REV.	DESCRIPTION	DR.BY	ECN. NO.

DR.BY: Judyyan	GENERAL TOLERANCE:		PART NO : A2019M-XXS-01-XX
CHKD.: Aren	LINEAR	ANGLES	DWG. NO.:
APPD.: Billy	X.: ±	X': ±5.0°	TITLE :
	X.X: ±0.30	X.X': ±3.0°	2.0mm Pitch Wafer SMT Type
	X.XX: ±0.20	X.XX': ±2.0°	DATE: 20-Jul-2021
	X.XXX: ±0.10	X.XXX': ±1.0°	

SHEET: 1/1	
SCALE: 1:1	
UNIT: mm	

HJBRIGHT 東莞市華晶電子有限公司
BRIGHT-E ELECTRONIC TECHNOLOGY LIMITED

THIRD ANGLE PROJECTION

A4

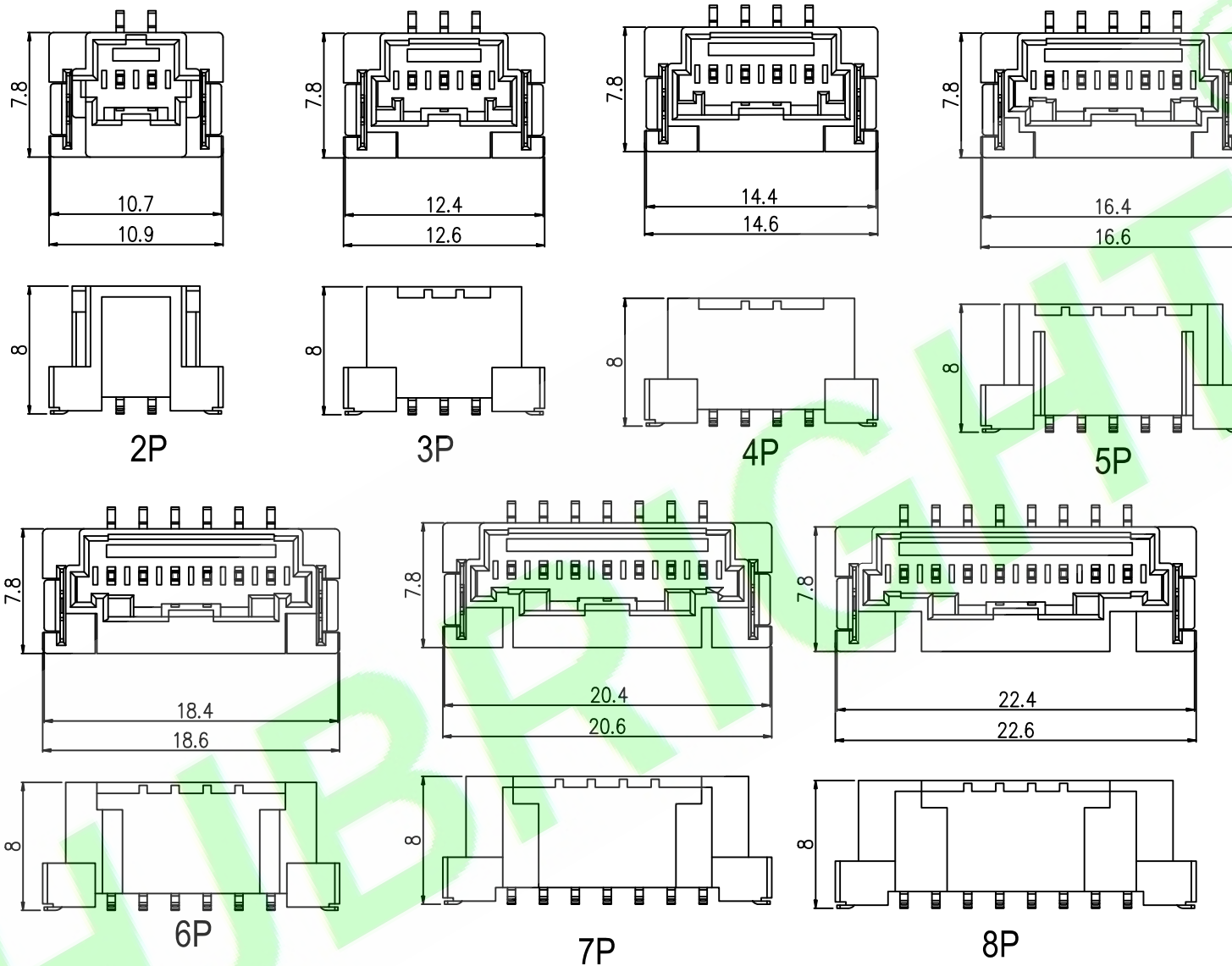

REV.	DESCRIPTION	DR.BY	ECN. NO.
3X	Update the plastic material to PA6T	Judyyan	20260429
2X	Update Drawing	Bin	20250709
1X	ORIGINAL	Judyyan	

DR.BY: Judyyan	GENERAL TOLERANCE:		PART NO : A2019M-XXS-01-XX
CHKD.: Aren	LINEAR	ANGLES	DWG. NO.:
APPD.: Billy	X.: ±	X': ±5.0°	TITLE :
	X.X: ±0.30	X.X': ±3.0°	2.0mm Pitch Wafer SMT Type
	X.XX: ±0.20	X.XX': ±2.0°	DATE: 20-Jul-2021
	X.XXX: ±0.10	X.XXX': ±1.0°	

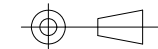
SHEET: 1/1	 THIRD ANGLE PROJECTION	A4
SCALE: 1:1		
UNIT: mm		

HJBRIGHT® 東莞市華晶電子有限公司
 BRIGHT-E ELECTRONIC TECHNOLOGY LIMITED