

Specifications:
 Material And Finish:
 Insulator:Nylon
 MAT Seal:Inherently lubricated Silicone
 Ring Seal:Inherently lubricated Silicone

Rating:
 Voltage Rating:14V AC/DC
 Operating Temperature Range:-40°~+150°C

Electrical:
 Contact resistance:10m ohm Max
 Insulator resistance:100M ohm min.
 Withstanding Voltage:1500V AC/Minute
 Selaling:Meets IP67

Ordering Information
 H35000F-XXP-XX-XXA
 1 2 3 4 5 6 7

- 1:— Series No.
- 2:— F:Female
- 3:— No. of Positions
- 4:— 01:Without clipslot receptacle housing
 02:With clipslot receptacle housing
- 5:— A:A Type
 B:B Type
 C:C Type
 D:D Type
 E:A Type
- 6:— B:Black
 LG:Light Gray
 DG:Dark Gray
 SG:Stone Gray
 Y:Yellow
- 7:— A:In Bag

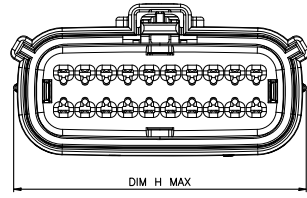

Applies to UL-V0 Configurations only

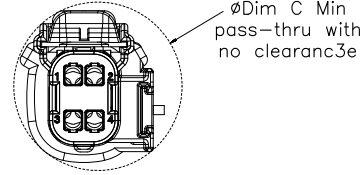

Applies to 2*2-STD.
 -With clipslot only

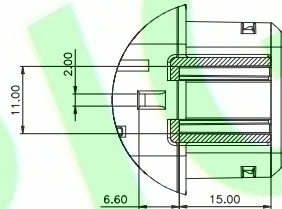
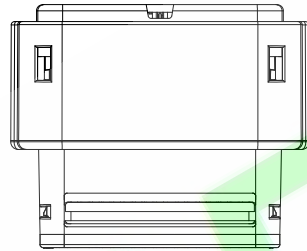
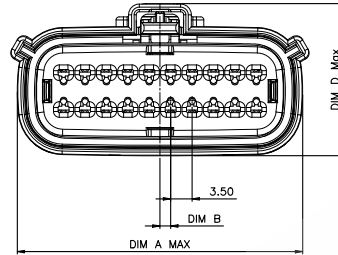

Partial X-X
 Scale 3:1

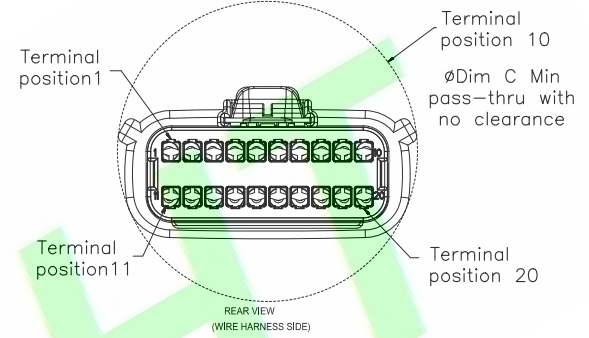

REAR VIEW
 (WIRE HARNESS SIDE)

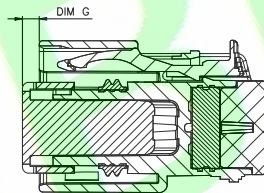
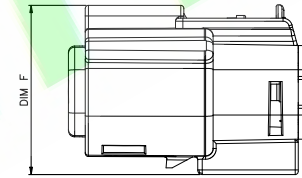

Primary lock Reinforcement(PLR)
 Shown In Pre-staged Position
 Section Y-Y

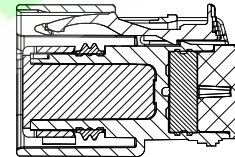

Primary lock Reinforcement(PLR)
 Shown In Final-Lock Position
 Section Z-Z

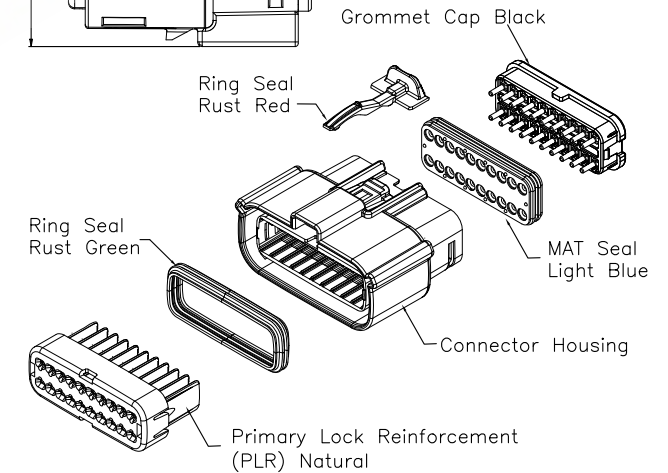

Description		Charted Dimensions							
		A	B	C	D	E	F	G	H
04P	Without Clipslot	18.75	1.75	25.45	24.90	37.65		2.75±0.50	
	With Clipslot	18.75	1.75	27.65	24.90	37.65		2.75±0.50	
06P	Without Clipslot	22.25	3.50	30.50	24.90	37.65	27.96	4.0±0.40	
	With Clipslot	22.25	3.50	26.24	24.90	37.65		4.0±0.40	
08P	Without Clipslot	25.75	1.75	31.50	24.90	37.65	28.00	2.75±0.50	27.04
	With Clipslot	25.75	1.75	29.19	24.90	37.65		2.75±0.50	27.04
12P	Without Clipslot	32.75	1.75	35.58	24.90	37.65	27.76	2.75±0.50	
	With Clipslot	32.75	1.75	35.58	24.90	37.65		2.75±0.50	34.04
16P	Without Clipslot	39.80	1.75	42.25	24.90	37.65		4.0±0.40	
	With Clipslot	39.80	1.75	42.25	24.90	37.65	27.80	4.0±0.40	
20P	Without Clipslot	46.75	1.75	49.95	24.90	37.65		2.75±0.50	48.04
	With Clipslot	46.75	1.75	49.95	24.90	37.65	27.80	2.75±0.50	

DR.BY.: Judyyan	GENERAL TOLERANCE:		PART NO : H35000F-XXP-XX-XXA	
CHKD.: Hu.ch	LINEAR	ANGLES	DWG. NO.:	
	X.: ±0.30	X': ±5.0°	TITLE :	
	X.X: ±0.20	X.X': ±3.0°	MX150 Rcpt Dual Row Sealed Assembly Mat Seal Female	
	X.XXX: ±0.10	X.XXX': ±1.0°	DATE: 09-Oct-2023	
APPD.: Billy				

HJBRIGHT 東莞市華晶電子有限公司
 BRIGHT-E ELECTRONIC TECHNOLOGY LIMITED

SHEET: 1/3
 SCALE: 1:1
 UNIT: mm

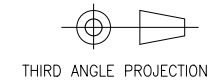

A4

1X	ORIGINAL	Judyyan	
REV.	DESCRIPTION	DR.BY	ECN. NO.

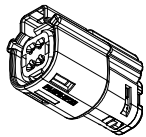

4PIN Without clipslot receptacle housing

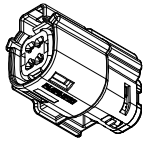

4PIN With clipslot receptacle housing

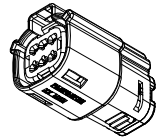

6PIN Without clipslot receptacle housing

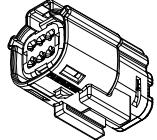

6PIN With clipslot receptacle housing

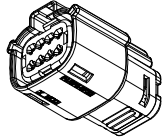

8PIN Without clipslot receptacle housing

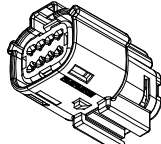

8PIN With clipslot receptacle housing

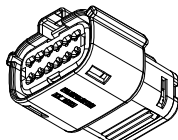

12PIN Without clipslot receptacle housing

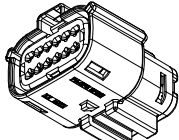

12PIN With clipslot receptacle housing

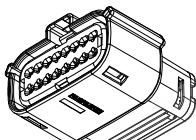

16PIN Without clipslot receptacle housing

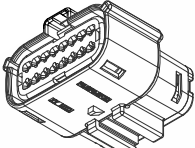

16PIN With clipslot receptacle housing

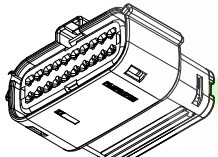

20PIN Without clipslot receptacle housing

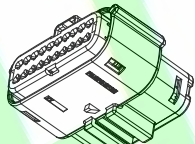

20PIN With clipslot receptacle housing



DR.BY.: Judyyan	GENERAL TOLERANCE:		PART NO : H35000F-XXP-XX-XXA
CHKD.: Hu.ch	LINEAR	ANGLES	DWG. NO.:
	x.: ±0.30	x': ±5.0°	TITLE :
APPD.: Billy	x.xx: ±0.20	x.x': ±3.0°	MX150 Rcpt Dual Row Sealed Assembly Mat Seal Female
	x.xxx: ±0.10	x.xxx': ±1.0°	DATE: 09-Oct-2023

HJBRIGHT® 東莞市華晶電子有限公司
BRIGHT-E ELECTRONIC TECHNOLOGY LIMITED

SHEET: 3/3
SCALE: 1:1
UNIT: mm

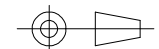

THIRD ANGLE PROJECTION

A4

1X	ORIGINAL	Judyyan	
REV.	DESCRIPTION	DR.BY	ECN. NO.

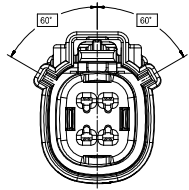

A Type
Black or Yellow

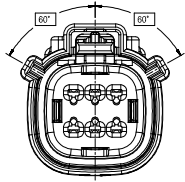

A Type
Black or Yellow

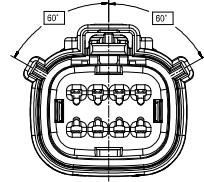

A Type
Black or Yellow

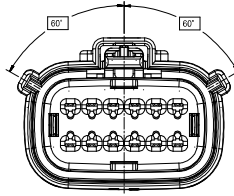

A Type
Black or Yellow

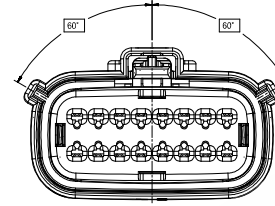

A Type
Black or Yellow

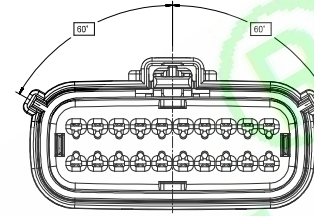

A Type
Black or Yellow

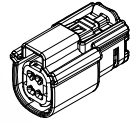

4P

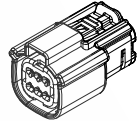

6P

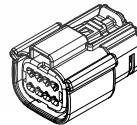

8P

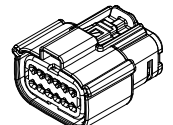

12P

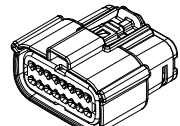

16P

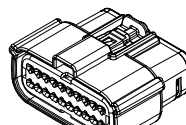

20P

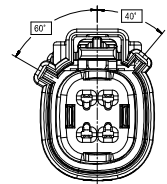

B Type Light Gray

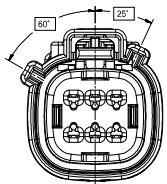

B Type Light Gray

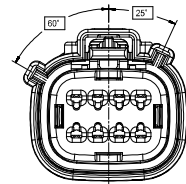

B Type Light Gray

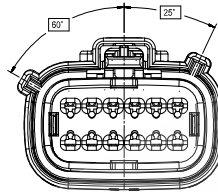

B Type Light Gray

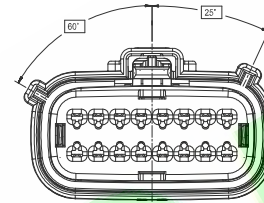

B Type Light Gray

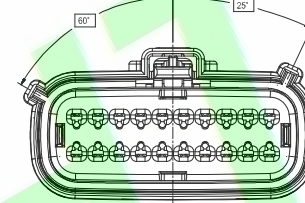

B Type Light Gray

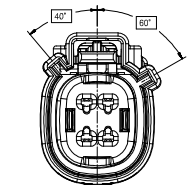

C Type
Brown or Dare Gray

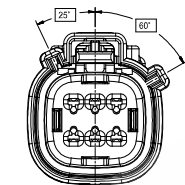

C Type
Brown or Dare Gray

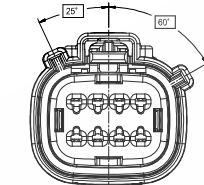

C Type
Brown or Dare Gray

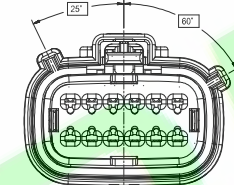

C Type
Brown or Dare Gray

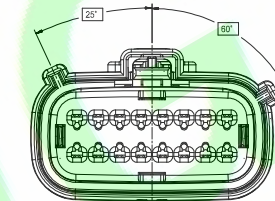

C Type
Brown or Dare Gray

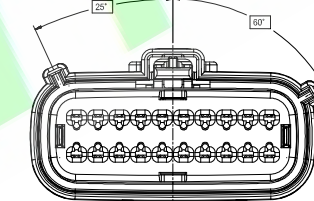

C Type
Brown or Dare Gray

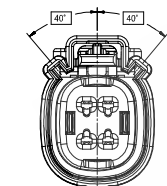

D Type
Green or Stone Gray
4P

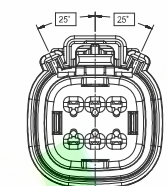

D Type
Green or Stone Gray
6P

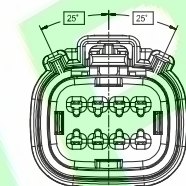

D Type
Green or Stone Gray
8P

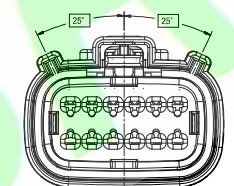

D Type
Green or Stone Gray
12P

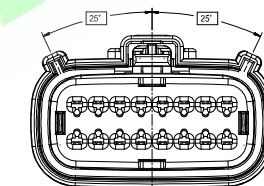

D Type
Green or Stone Gray
16P

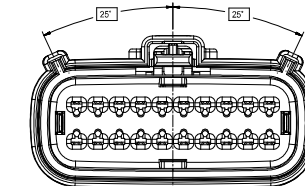

D Type
Green or Stone Gray
20P

DR.BY.: Judyyan	GENERAL TOLERANCE:		PART NO : H35000F-XXP-XX-XXA	
CHKD.: Hu.ch	LINEAR	ANGLES	DWG. NO.:	
APPD.: Billy	x.: ±0.30	x': ±5.0°	TITLE : MX150 Rcpt Dual Row Sealed Assembly Mat Seal Female	
	x.xx: ±0.20	x.xx': ±2.0°	DATE: 09-Oct-2023	
	x.xxx: ±0.10	x.xxx': ±1.0°		

HJBRIGHT 東莞市華晶電子有限公司
BRIGHT-E ELECTRONIC TECHNOLOGY LIMITED

SHEET: 2/3
SCALE: 1:1
UNIT: mm

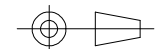

THIRD ANGLE PROJECTION

A4

1X	ORIGINAL	Judyyan	
REV.	DESCRIPTION	DR.BY	ECN. NO.